

Focus II/2003 

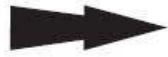





Ⓜ Location/Position Arrow

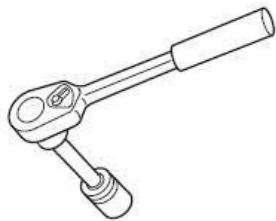
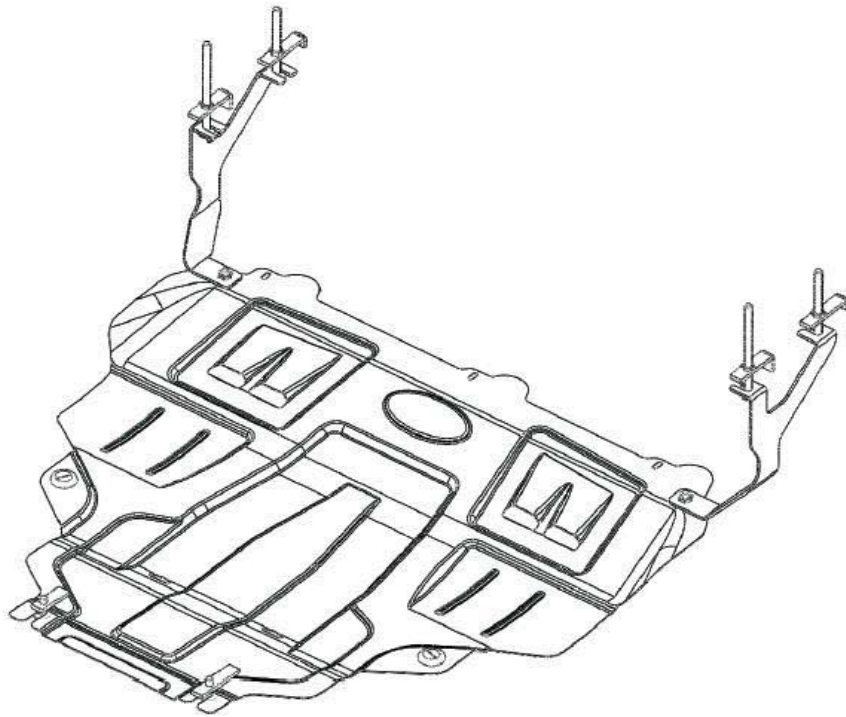

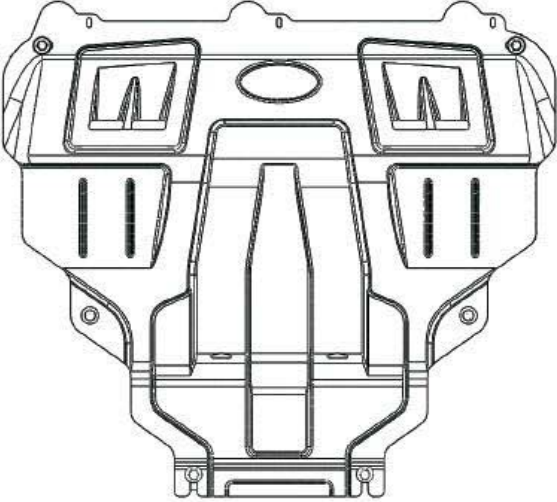
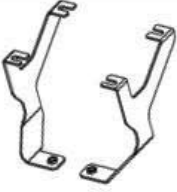
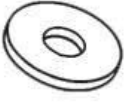
Ⓜ Movement Arrow

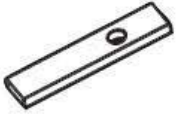
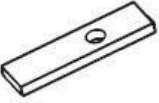
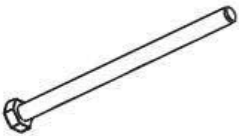
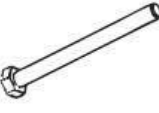

<b>A</b>				1X	
<b>B</b>		1X	<b>C</b>		8X
<b>D</b>		2X	<b>E</b>		2X
<b>F</b>		1X	<b>G</b>		1X
<b>H</b>		2X	<b>I</b>		2X
<b>J</b>		2X	<b>K</b>		2X
08.1504				3/6	

